

STEP 6. (Optional)
Insert **LABELS (I)** to front of **BINS (F, G, H)**.

Shop for additional bin rack parts and accessories at sevilleclassics.com.

- **Bin dividers (6-Pack)**, Model no.: WEBK401
- **Medium bins (3-Pack)**, Model no.: WEBK403
- **Large bins (3-Pack)**, Model no.: WEBK400
- **Extra-large bins (2-Pack)**, Model no.: WEBK402

Caution

- Place heavier items on the lower shelves and lighter ones on the top.
- Do not stand or climb on the shelving system.
- Do not drop heavy items on the system.
- Do not move the system while loaded.

Specifications

Dimensions: 36" W x 14" D x 56" H

| Weight capacity | Per shelf | Overall |
|-----------------|-----------------------------|-----------------------------|
| On wheels | 71.2 lbs. (32.3 kg.) | 500 lbs. (226.8 kg.) |

Customer Service Information

Seville Classics, Inc

Telephone: (800) 323-5565

Fax: (310) 533-3899

Hours: 8:30 AM – 4:30 PM (PST)

Email: Support@SevilleClassics.com

Online Store: www.SevilleClassics.com

082023

seville classics®

7-Tier 22-Bin Commercial-Grade NSF Bin Rack

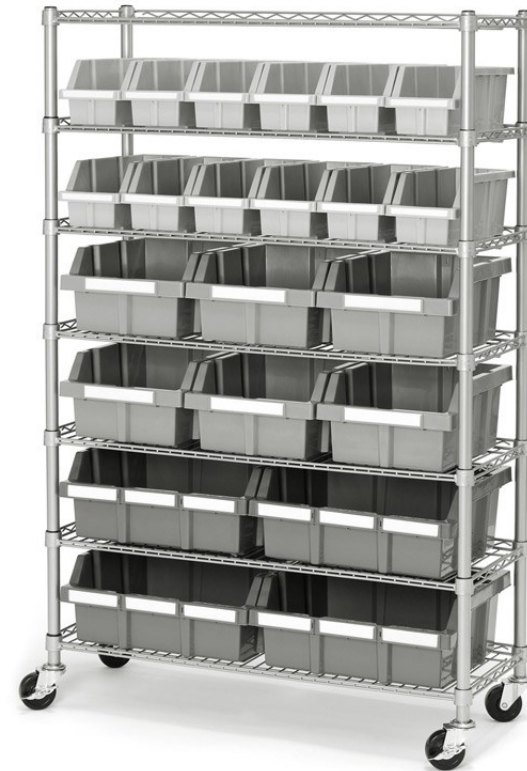



Model #: WEB452/SHE16511BX

Thank you for choosing Seville Classics! We hope that you enjoy your commercial-grade steel wire shelving! Please read through this guide for parts list, assembly instructions, frequently asked questions and further contact information.

082023

Parts List

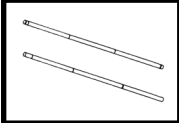
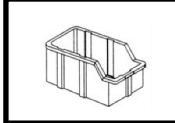
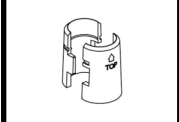
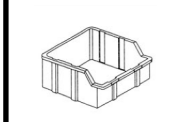
Please make sure you have all the parts on this list.

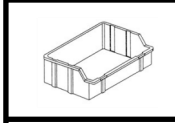
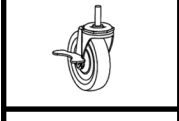
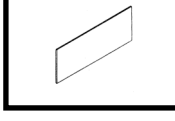
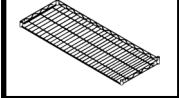
| | | | |
|--------------------------|---|------------------------|---|
| A. Pairs of poles (4) |  | F. Medium bin (12) |  |
| B. Slip-sleeves (28) |  | G. Large bin (6) |  |
| C. 3" Wheels (2) |  | H. Extra-large bin (4) |  |
| D. 3" Locking wheels (2) |  | I. Label (30) |  |
| E. Shelves (7) |  | | |

If you're missing parts, contact us for replacements at (800) 323-5565 or send an email to Support@SevilleClassics.com

Assembly Instructions

You can view an assembly video [here](#) or scan the following QR code →



STEP 1.

Screw **WHEELS (C, D)** into base of bottom poles.

Repeat for all bottom poles.

STEP 2.

Snap **SLIP SLEEVES (B)** around the grooves on **BOTTOM POLES (A)** for your lowest shelf.

TIP! Count the number of grooves from the bottom of the pole to keep the height consistent.

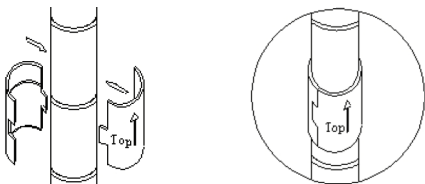
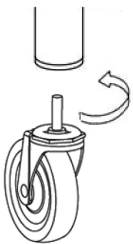

STEP 3.

Fit **SHELF (E)** over the top of the 4 poles and over **SLIP SLEEVES (B)**.

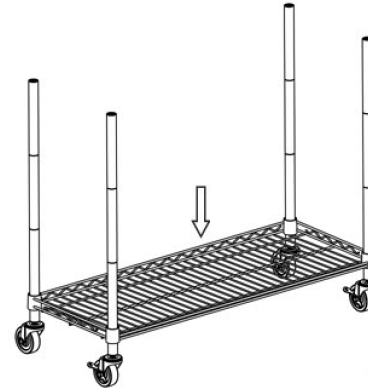

Repeat **STEPS 2-3** for next shelf.

TIP! If necessary, lightly tap shelves into place with a rubber mallet.

STEP 4.

Screw **PAIRS OF POLES (A)** together.

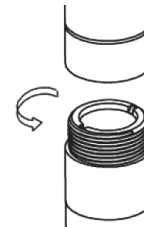

STEP 5.

Repeat **STEPS 2-3** for remaining shelves.

Set **BINS (F, G, H)** on shelves.

Congratulations!

Your bin rack system is now assembled.

